

BEFORE USE:

Please read the instructions carefully. You must inspect the appliance including its cable and plug for any signs of damage. If the product is damaged, DO NOT USE and contact your supplier immediately for refund or replacement.

This product is only suitable for well insulated spaces or occasional use.

MYZEK®

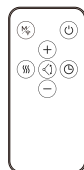
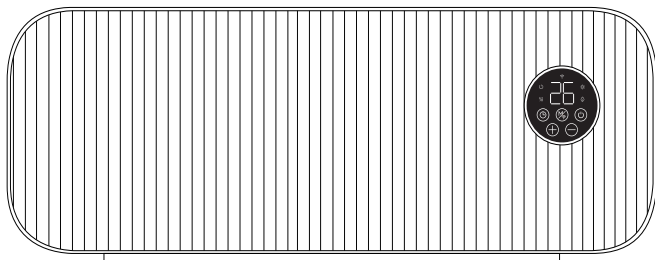

V 2024-08

INSTRUCTION MANUAL FOR MODELS

WALL MOUNTED PTC FAN HEATER

MY284852 / MY284853

| GENERAL INFORMATION

Thank you for choosing the Mylek wall mounted PTC fan heater. Please take time to carefully read and understand the entire instruction manual before using the product and then save it for future reference. We reserve the right for any errors in text or images and any necessary changes made to technical data. If you have any questions concerning operational or technical problems please contact our Customer Services on **0800 091 3171**.

| BEFORE USING THIS HEATER

When using electrical appliances, basic precautions should always be followed to reduce the risk of fire, electric shock, and injury to persons. This includes but is not limited to the following.

CAUTION

This appliance is not intended for use by persons (including children) with reduced physical, sensory or mental capabilities, or lack of experience and knowledge of the product. The appliance is to be operated by responsible adults only after reading and understanding these instructions. Children should be supervised at all times to ensure that they do not play with the appliance. Children under 16 years should not operate the unit or carry out maintenance and/or clean the unit. Any infirmed persons in the vicinity of the unit should be accompanied by a responsible and competent

able bodied adult. Remove the packing and make sure that the appliance is intact. If there is any doubt concerning the integrity of the unit do not use the appliance and contact our recommended after-sales service.

Do not leave any packaging materials within easy reach of children. Before switching on appliance check if the electrical voltage and frequency of the circuit correspond to those indicated on the appliance. Use the appliance only for the stated purpose, namely as a heater for domestic use. Do not use it for any other application as it could be dangerous.

| IMPORTANT SAFETY REQUIREMENTS

- This appliance can be used by children aged from 8 years and above and persons with reduced physical, sensory or mental capabilities or lack of experience and knowledge if they have been given supervision or instruction concerning use of the appliance in a safe way and understand the hazards involved. Children shall not play with the appliance. Cleaning and user maintenance shall not be made by children without supervision.
- Children of less than 3 years should be kept away unless continuously supervised.
- Children aged from 3 years and less than 8 years shall only switch on/off the appliance provided that it has been placed or installed in its intended normal operating position and they have been given supervision or instruction concerning use of the appliance in a safe way and understand the hazards involved. Children aged from 3 years and less than 8 years shall not plug in, regulate

and clean the appliance or perform user maintenance.

- **CAUTION** - Some parts of this product can become very hot and cause burns. Particular attention has to be given where children and vulnerable people are present.
- If the supply cord is damaged, it must be replaced by the manufacturer, its service agent or similarly qualified persons in order to avoid a hazard.
- **CAUTION:** In order to avoid a hazard due to inadvertent resetting of the thermal cutout, this appliance must not be supplied through an external switching device, such as a timer, or connected to a circuit that is regularly switched on and off by the utility.
- The heater must not be located immediately below a socket-outlet.
- Means for disconnection having a contact separation in all poles must be incorporated in the fixed wiring in accordance with the wiring rules.
- For correct installation on the wall, thanks to refer to 'Installation on wall' part.
- Fixed heaters are to be installed so that switches and other controls cannot be touched by a person in the bath or shower.
- **WARNING:** In order to avoid overheating, do not cover the heater.
- Do not use this heater if it has been dropped.
- Do not use if there are visible signs of damage to the heater.
- Use this heater on a horizontal and stable surface, or install correctly and securely to a wall, as shown in this user manual.
- The heater must be installed at least 1.8m above the floor.

- **WARNING:** Do not use this heater in small rooms when they are occupied by persons not capable of leaving the room on their own, unless constant supervision is provided.
- **WARNING:** To reduce the risk of fire, keep textiles, curtains, or any other flammable material a minimum distance of 1m from the air outlet.
- **PLEASE NOTE:** Household dust, lit cigarettes, candles and oil burners, combined with the convection effect of electric heaters can cause significant soot deposits to build up on the surface directly above and to the sides of the heater. This is not a fault of the heater. Extensive burning of candles or smoking in the operating environment of this product can produce heavy discolouration within a few months of use.

Notice to Landlords, Universities, Housing Associations, Charitable Associations Or Other Similar Associations:

It is your responsibility to your Tenants where these heaters are fitted to make sure Risk Assessments are carried out for these heaters and your Tenant's are fully trained on how to operate this heater correctly and safely. The Tenant's are also given a copy of these user instructions for guidance and understand the importance of reading them and keeping them safe and at hand at all times. The Tenant's should also understand the safety importance of NEVER covering the heater or heater vents at any time for drying or warming garments, or any types of materials. The Tenant's should also be trained about the correct clearance around the heater at all times. Not following correct guidance and training could result in the unit overheating system activating, risk of

fire, injury or even death.

WARNING: this product should only be installed in Zone 3 only if fitted in a bathroom according the national wiring rules.

Note: The drawing below is for reference only.

If this unit is fitted in a bathroom then it should be fitted by a qualified electrician.

In the case as of buildings room, a room receiving a bath or a shower and socket-outlets lower or equal to 32 A the circuit corresponding must be protected by a device with differential residual current (RCD) lower or equal to 30 mA.

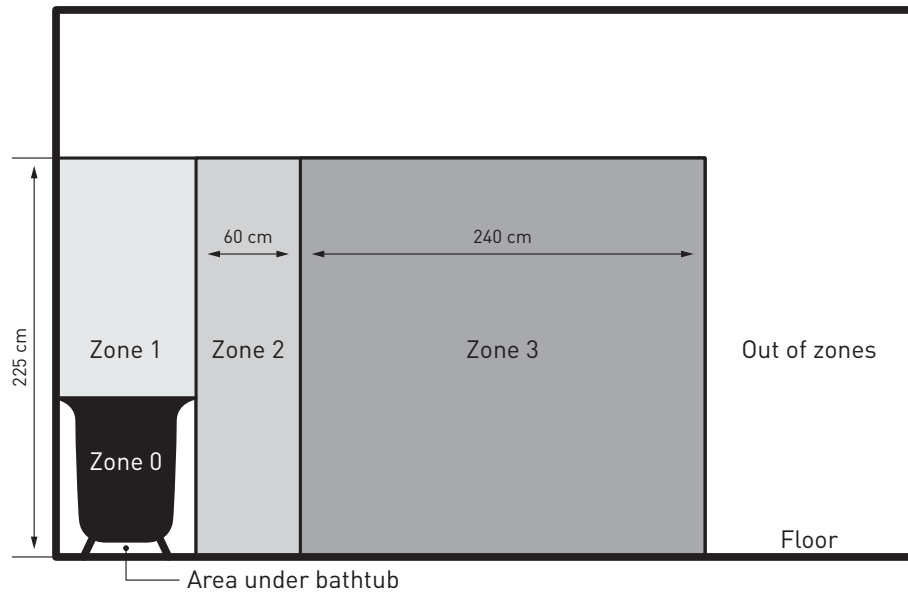

THIS PRODUCT IS FOR ROOM HEATING
FOR HOUSEHOLD USE ONLY

STRUCTURE AND PARTS

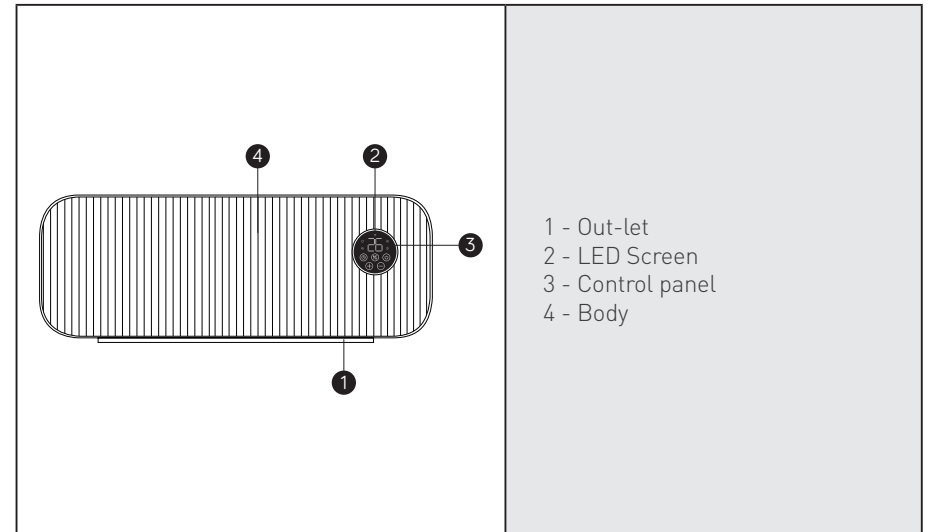

SPECIFICATIONS

Model No.	RATED VOLTAGE	RATED POWER
MY284852	AC230V, 50-60Hz	2000W
MY284853	AC230V, 50-60Hz	2000W

| INSTALLATION ON THE WALL

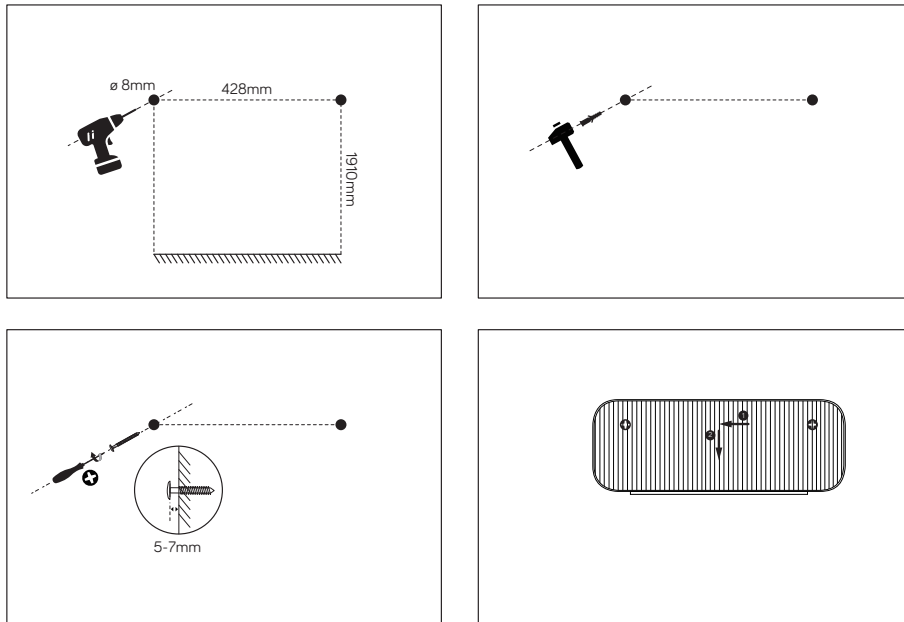



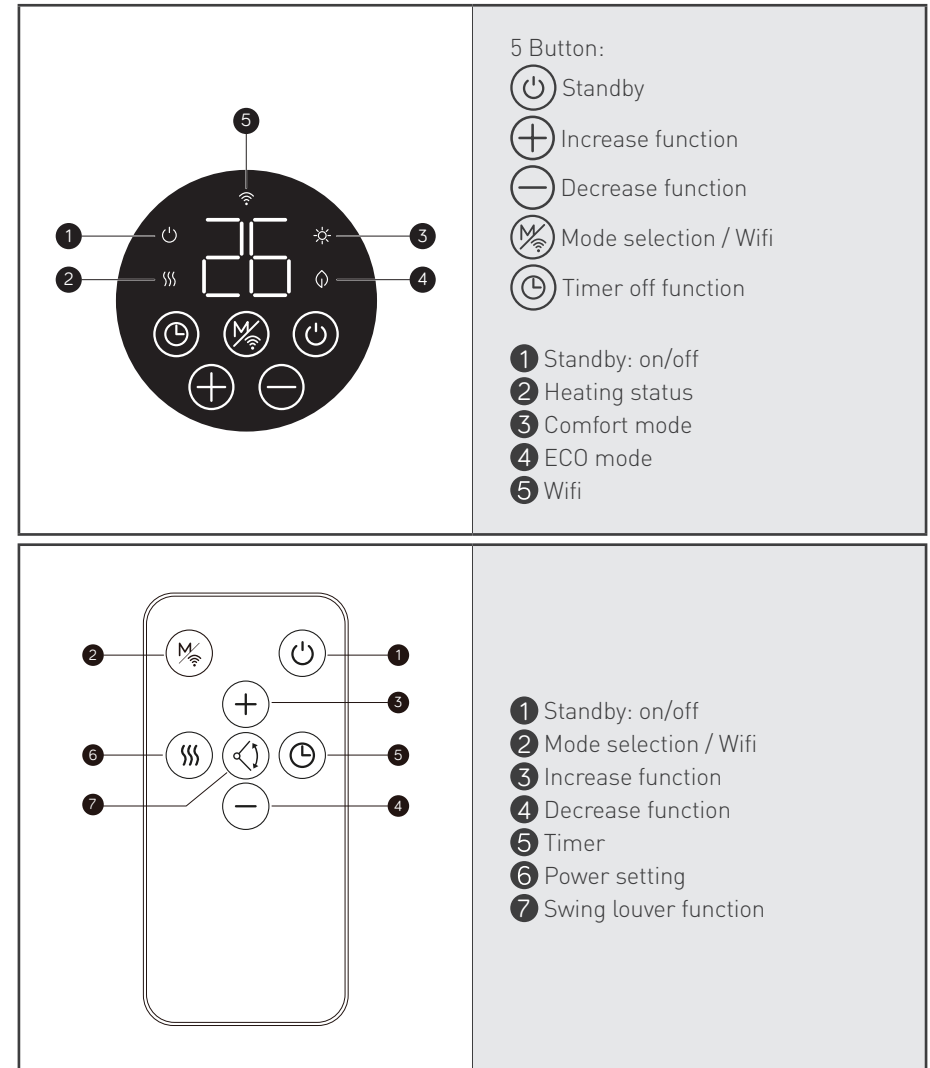

1. Drill holes on the wall according to the above instruction.
Warning: Be sure to keep the safety distances as shown on the above drawing.
2. Fit the plastic wall plugs into the drilled holes and fit the screws.
3. Hang the unit on the screws gently.
Warning: Before using the heater, make sure it's mounted tightly on the wall.

| CONTROL PANEL AND SCREEN









| HOW TO USE

- Plug the appliance into a AC 230V 50-60Hz socket and press the on/off switch located

- on the back cover, you will hear a beep sound. The power indicator light  shows on.
 - Press  to turn on the heater, which is in factory default setting when used for the first time.
 - Factory default:
 - Heating mode: Comfort mode
 - Target temperature setting: 22°C
 - Window open function: Off
 - Timer: Off
- (If default settings are different, it will simply be because the unit has been quality tested after production).
- To stop the heater working, press  to turn off the heater, the  indicator will display, the heater will blow cool air for around 60 seconds to discharge heat and protect the element.
 - Unplug the product when it's not in use.





| TEMPERATURE SETTING

When the screen display the target set temperature, press  and  to set directly:









-  Comfort mode or Comfort mode in P1/P2/P3: Press  and  to set the temperature from 5-35 °C.
-  ECO mode or ECO mode in P1/P2/P3: Press  and  to set the temperature from 1-31 °C.

Note: ECO mode=Comfort mode - 4 °C.

| CLOCK SETTING

- Press button  for 3 seconds to enter clock and day of week setting
- The screen will display , press  and  to select the current day from 1-7.

1	Monday	2	Tuesday
3	Wednesday	4	Thursday
5	Friday	6	Saturday
7	Sunday		





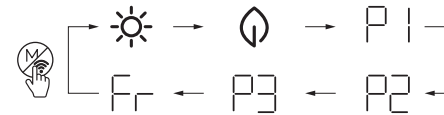

- Press  to confirm day setting and enter the clock hour setting, with the screen display: .
- Press  and  to set the current hour from 00-23
- Press  to confirm hour setting and enter the minute setting, with the screen display: .
- Press  and  to set the current minute
- Press  to confirm all settings

Note: The clock and calendar will be reset to factory default if without power supply.

| FUNCTIONS SETTING EXPLAINED

Press  to enter mode selection. By pressing , heating mode runs in a continuous cycle as below:



-  Comfort mode: Press  and  to set the temperature from 5-35°C.
-  ECO mode: Press  and  to set the temperature from 1-31°C.
- Note: ECO mode=Comfort mode - 4 °C
- Anti-frost mode: the screen display . The target temperature is 7 °C. The temperature can't be adjusted.
- P1/P2/P3: Pre-set heating program.

Note: If the clock and day setting are not set correctly P1/P2/P3 will not operate to the current time. it is advised to set day and clock setting in advance.

: (Monday-Sunday) Pre-set program, cannot be adjusted.

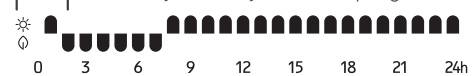

: (Monday-Friday) Pre-set program, cannot be adjusted.



: (Saturday-Sunday) Pre-set program, cannot be adjusted.



: (Monday-Friday) Adjustable program



: (Saturday-Sunday) Adjustable program



adjustable program setting

1. Press until the mode displays, press again for 3 seconds to enter day setting.
2. The screen displays , press and to set from - (Monday-Sunday). Press to confirm and enter hour setting.
3. The screen displays , press and to set from {00-23}. Press to choose heating mode for every hour (Comfort mode , ECO mode or no symbols for anti-frost mode. Please note under the anti-frost mode, the heater will only operate if the temperature drops to 7°C)
4. Repeat the operation until you have completed the schedule of every hour and every day.

Note: After setting heating mode for hour 23, press to come back to day setting.

Note: when screen displays , press finish all setting with display of .

| POWER SETTING

The power can be set with remote control by pressing to set.

: Fan mode; : 1000W; : 2000W

| COUNTDOWN TIMER FUNCTION

Press the once, the screen displays "" and keeps flashing, keep pressing , the screen will display 2H - 4H - 8H - 0H in a cycle. Or press and to set timer from 0-9 hours.

| SWING LOUVER FUNCTION

Press on the remote to turn on and off swing louver function.

| OPEN WINDOW FUNCTION

- To turn on open window function, press together and , the screen will display , after 3 seconds, the screen will display the set temperature.
- To turn off open window function, press together and , the screen will display , after 3 seconds, the screen will display the set temperature.

| SCREEN CHILD SAFETY LOCK

- To active the child lock, simply press on APP UI and then the control panel will be locked.
- To exit the child lock, press and together to unlock the control panel OR press on APP UI.

| PAT TESTING

When used in a workplace, this product must be safety-tested yearly by a qualified electrician (PAT Tested) in order to comply with the Electricity at Work Regulations. We recommend that it is PAT tested regularly when used in a domestic environment.

| MAINTENANCE

1. Always disconnect the appliance and let it completely cool before any maintenance.
2. Use a vacuum cleaner to remove dust on grilles.
3. Clean the outside of the unit with a damp cloth and then dry it with a dry cloth. Never immerse the unit in water, nor let water drip into the unit.

| STORING

1. Always disconnect the appliance, let it completely cool and clean it before storing.
 2. If you do not use the device for a long period, put back the unit and the instruction manual to the original carton and store in a dry and ventilated place
- Do not place any heavy items on top of carton during storing as this may damage the appliance.

| WIFI CONNECTION

Use your phone to scan the QR code below or search for the **“TUYA SMART”** App to download and generate a free account. You can also visit www.tuya.com for more information. Please note Tuya are constantly developing and upgrading their Apps to make them more user friendly and sometimes, displays may differ slightly to the display shown in this manual due to upgrades. If you have any questions concerning technical problems, please contact our Customer Services on **0800 091 3171** quoting the model number found on the unit rating label. information. Please note Tuya are constantly developing and upgrading their Apps to make them more user friendly and sometimes, displays may differ slightly to the display shown in this manual due to upgrades. If you have any questions concerning technical problems, please contact our Customer Services on **0800 091 3171** quoting the model number found on the unit rating label.



Select your country code, enter your mobile number and select “Get” to receive a message containing your verification code.

Enter your verification code and select “Login”.

When the first using to turn on the heater, the WiFi indicator light will flash, connect it in the APP.

Reset the WiFi, press  for 3 secs, the WiFi indicator light will flash rapidly , you can now connect within the APP.

A Quick connection :

Turn on your bluetooth in you mobile phone, then set as following steps.

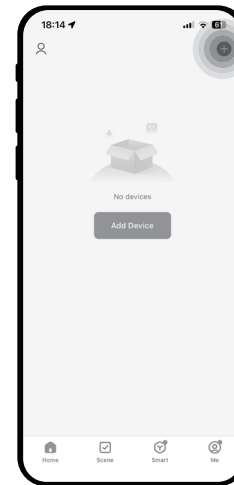

Press “+” in the right-top position and go to next step

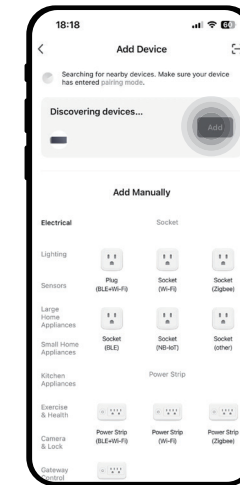

Press “Add”

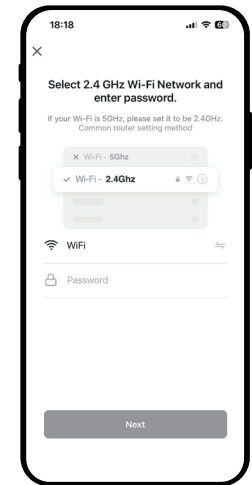

Select 2.4 GHz WiFi Network and enter the password, press next

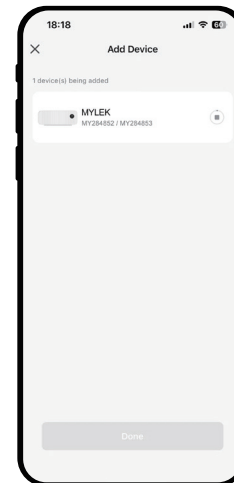

Wait it's connected and press “Next”, the APP will show as below

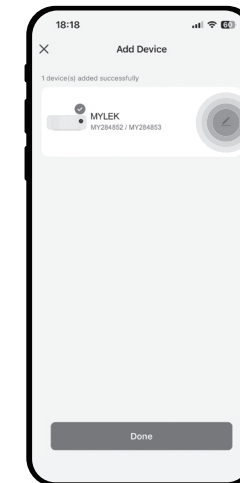

You can press to modify the name of the product

B Normal connection :

If the bluetooth is not on, pls follow the next step.

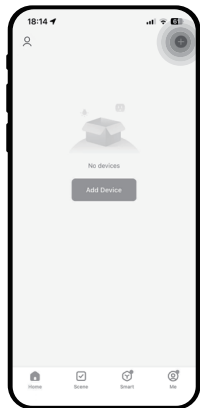

Press "+" in the right-top position and go to next step

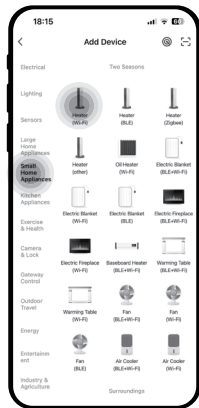

Choose small home appliance and heater

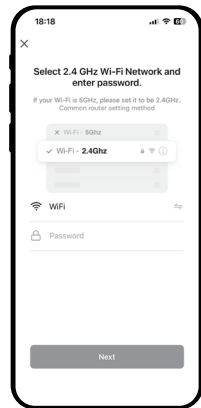

Select 2.4 GHz WiFi Network and enter the password, press next



Pls ensure the wifi logo is twinkling, if not, pls long press for 5 seconds until the WiFi logo start to twinkle



Press "Blink Quickly"

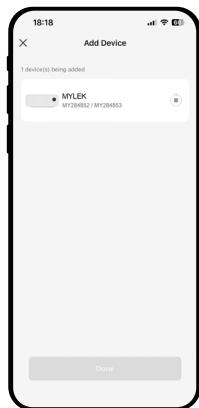

Wait it's connected and press "Done", the APP will show as below



You can press to modify the name of the product

UI interface :



- Temperature set
- Room temperature
- Display on/off
- Turn on/off the heater
- Working mode selection
- Temperature set
- Timer set
- Weekly program (P7) set
- Windows open
- Timer
- Setting
- Child lock
- Quick set

Please note when choosing P1/P2/P3 in the APP, the unit will operate to the settings shown in the manual. If you set P3 manually on the unit and you choose P3 in the APP the unit will operate to the settings you have set. You can also choose to set to your own requirements by selecting the Weekly program P7 within the App.

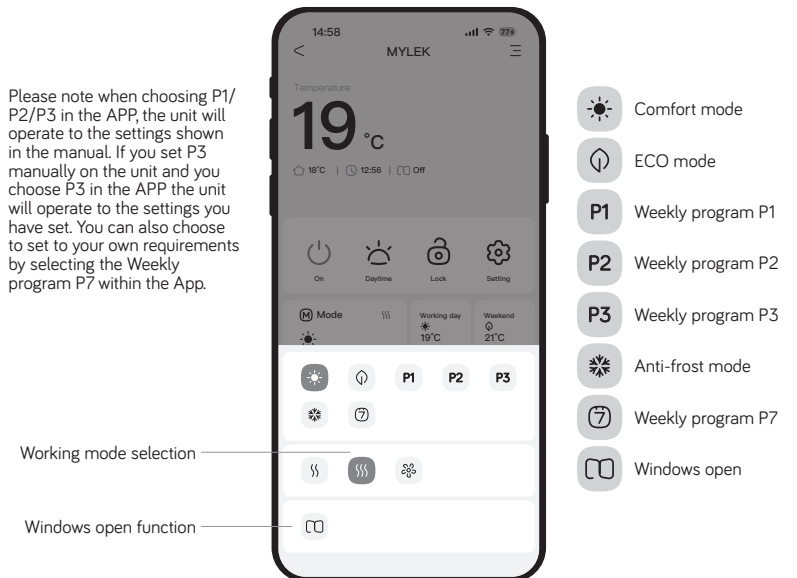

- Comfort mode
- ECO mode
- P1 Weekly program P1
- P2 Weekly program P2
- P3 Weekly program P3
- Anti-frost mode
- Weekly program P7
- Windows open
- Working mode selection
- Windows open function

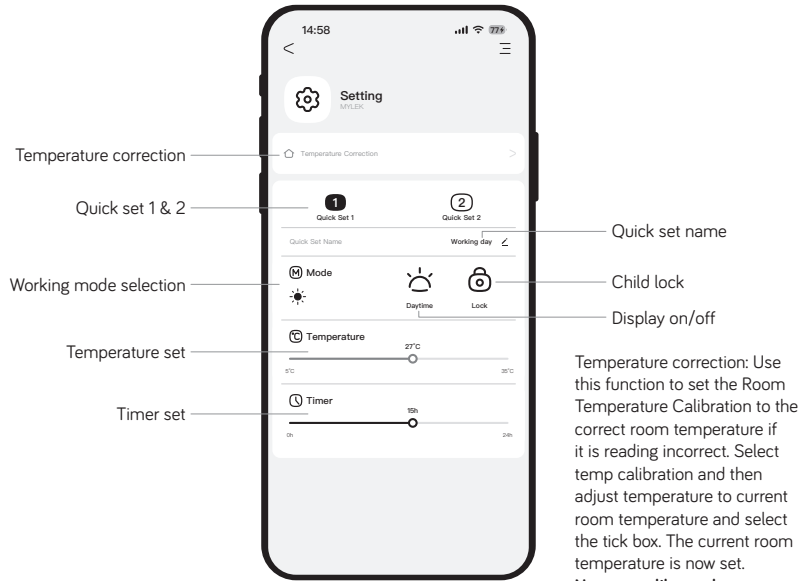

Temperature correction: Use this function to set the Room Temperature Calibration to the correct room temperature if it is reading incorrect. Select temp calibration and then adjust temperature to current room temperature and select the tick box. The current room temperature is now set.

Note: to calibrate the temperature, pls ensure the heater already worked for more than 1 hour.
Customer can preset usual using way in different situation and name it (can keep 2 quick set).

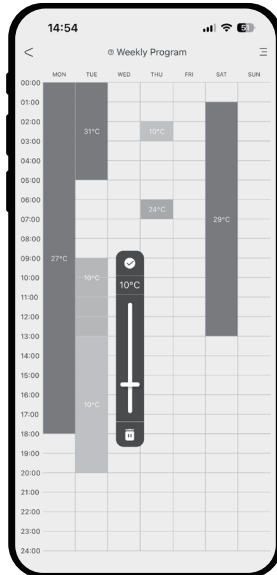

Weekly program (P7) : Set the working time and working temperature for every hour in everyday.

Information requirements for electric local space heaters

Model identifier(s): MY284852 / MY284853					
Item	Symbol	Value	Unit	Item	Unit
Heat output				Type of heat input, for electric storage local space heaters only (select one)	
Nominal heat output	P_{nom}	2,0	kW	Manual heat charge control, with integrated thermostat	[no]
Minimum heat output (indicative)	P_{min}	1,0	kW	Manual heat charge control with room and/or outdoor temperature feedback	[no]
Maximum continuous heat output	$P_{max,c}$	2,0	kW	Electronic heat charge control with room and/or outdoor temperature feedback	[no]
Auxiliary electricity consumption				Fan assisted heat output	
At nominal heat output	el_{max}	0	kW		[no]
At minimum heat output	el_{min}	0	kW	Type of heat output/room temperature control (select one)	
In standby mode	el_{sb}	0,001	kW	Single stage heat output and no room temperature control	[no]
				Two or more manual stages, no room temperature control	[no]
				With mechanic thermostat room temperature control	[no]
				With electronic room temperature control	[no]
				Electronic room temperature control plus day timer	[no]
				Electronic room temperature control plus week timer	[yes]
				Other control options (multiple selections possible)	
				Room temperature control, with presence detection	[no]
				Room temperature control, with open window detection	[yes]
				With distance control option (WiFi Option)	[yes]
				With adaptive start control	[no]
				With working time limitation	[yes]
				With black bulb sensor	[no]
Contact details	Hygiene Supplies Direct Limited, Ground floor, Tayson House, Methley Road, Castleford WF10 1PA				



This marking indicates that this product should not be disposed with other household wastes throughout the EU. To prevent possible harm to the environment or human health from uncontrolled waste disposal, recycle it responsibly to promote the sustainable reuse of material resources. To return your used device, please use the return and collection systems or contact the retailer where the product was purchased. They can take this product for environmental safe recycling.

The importer retains his right to make changes in appearance and completeness of the item without preliminary notification to the customer.

The item is for indoor use only.

The manufacturer does not assume any liability for any damage caused directly or indirectly by not following this instruction manual, general safety rules, or interference in the construction of the product.

| SERVICE WARRANTY

Hygiene Supplies Direct guarantees the product free from defects in materials and workmanship for a period of 1 year from date of purchase. Should this unit be operated under conditions other than those recommended, at voltages other than the voltage indicated on the unit, or any attempts made to service or modify the unit, then the warranty will be rendered void. The product you buy may sometimes differ slightly from illustrations. This warranty is in addition to, and does not affect, your statutory rights. If you have any problems with this product, please call our Help Desk on **0800 091 3171** or email: **sales@hygienesuppliesdirect.com**

MYLEK[®]

Hygiene Supplies Direct Limited, Ground Floor, Tayson House,
Methley Road Castleford, West Yorkshire, WF10 1PA
declares that the Mylek Heaters are exclusively manufactured
and imported for Hygiene Supplies Direct Ltd.